



GYMnastics
nastique

CANADA

**WOMEN'S ARTISTIC GYMNASTICS
EQUIPMENT SPECIFICATIONS AND MEASUREMENTS
PROCEDURES**

Version: February 2017

INTRODUCTION

This document provides information on the equipment specifications and the measurements procedures only. It is not a reference for the rules of FIG or the HP programs.

Before each competition session, the D1 judge must ensure that the equipment meets the specifications on her apparatus.

The FIG has stated that 5 cm mats are no longer allowed for international competitions. Some diagrams included in the present document come from FIG and from GYMNOVA Canada.

All specifications included in this manual are related to FIG Junior and Senior and HP Novice competition. A supplementary chart for apparatus specifications can be found in the JO and Aspire manuals.

VAULT

Vault Table: The vaulting table must be positioned on a rigid surface which is the same height as the runway. The support structure of the table (all steel) must be covered with cushioning front and back. The frame cushioning at the back must be at the same height as the landing mat as per FIG specification.

NOV/JR/SR Table Height 125 cm to the rigid surface (± 1 cm). If the vault is not on a rigid surface that is the same height of the vaulting runway (i.e. on the floor surface) the height of the vault will be measured to the top of the vault runway.

Runway: 25 metres (± 10 cm)
The run up area is composed of a run up mat and a rigid board underneath the vaulting board. The start of the run up shall be marked for training and competition. The length (25 m) is measured from the vertical projection of the beginning of the vaulting table to the inner side of the 25m mark. The runway must be weighted and secured to the floor to avoid movement of the runway during use.

Landing mats: 600 cm x 250 cm x 20 cm (± 1 cm)

Supplementary mat: 600 cm x 200 cm x 10 cm (± 1 cm)
The supplementary mat must be attached to the landing mat. Its use is mandatory for all national and international meets in Canada.
SR-JR-NO: (In Canada, an additional 5 cm mat may be used on top of the 10 cm supplementary landing mat)
Novice: A 20 cm safety mat is permitted.

Landing Corridor: The supplementary mat will be marked as follows to set the landing corridor:

- the stripes are 5 cm \pm 0.5 cm
- Width of the landing corridor at the table side 95 cm
- Width of the landing corridor at the end of the 600 cm landing mat 150 cm
- A center line (5 cm) will be placed on the landing mat in the center of the corridor.

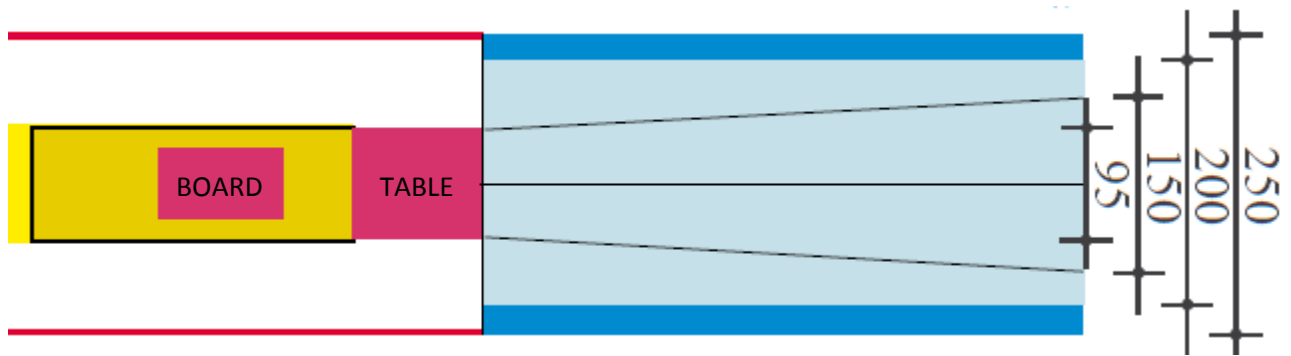

Boards (FIG): JR/SR: 2 boards available: Hard and Soft (FIG)
Novice: 3 boards available FIG Hard, FIG Soft, and a softer board

Training pit: If possible, GYMNOVA Canada will provide one training pit per table. The pit will be available for training only. It will not be available during the competition warm up.

Measuring the height of the table

From the landing end of the table, measure 68 cm and draw a line on top of the table towards the side of the table. Place a wooden board across the table, lining it up with the line drawn on the vault and measure from bottom of board overhanging on the side of the table to the rigid board (125 cm).

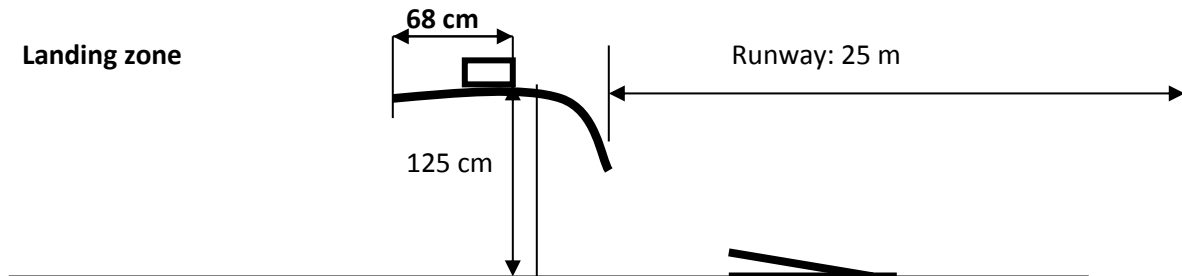

Judges' Tables:

There must be a minimum distance of 3 meters between the edge of the judges' tables and the edge of the mat. Judges may be seated on the same side of the vault table.

- 4 Judges chairs at table 1
- 2 set of flash cards for D and E scores placed in front of the D jury
- 1 Chair for a runner/Scoring assistant for redundant scoring set up seated at the table 1 next to the D1
- A number flash stand at the top of vault for Vault numbers (with chart of numbers attached)

Line Judges:

The line judge at Vault must sit at the far corner of the landing side.

Reference Camera:

The reference camera should be set up 2 m behind the position of the D panel. The camera must be on a fluid tripod and set such that the entire landing surface (from closest edge of mat to opposite) visible without obstruction and framed such that the camera does not need to be panned up or down (up to 4 m visible above table surface).

UNEVEN BARS

Apparatus: High bar: 250 cm to the floor (± 3 cm in Canada; ± 1 cm FIG)
 Low bar: 170 cm to the floor (± 3 cm in Canada; ± 1 cm FIG)
 Diagonal: Inner diagonal distance between the 2 bars adjustable from min 130 - 180 cm max ± 1.0 cm
 (At the increased height the inner diagonal distance between the bars shall be not more than 182 cm max ± 1.0 cm)

Landing mats: 1400 cm x 200 cm x 20 cm (± 1 cm)
 Mats are **centered** under the **middle** of the bars

Springboard: A soft springboard must be available.
 (A small plank may be available to place under the springboard – valid in Canada only)

Supplementary mat: 400 cm x 200 cm x 10 cm (± 1 cm). Its use is mandatory.
 An additional 10cm x 2m x 2m mat is permitted in Canada
 Junior/Senior: a 20cm mat may be slid in/out for release skills per the HP manual
 Novice: A 20 cm safety mat is permitted under the rails and for the dismount.

Safety Mat: A 20 cm safety mat is permitted under HP rules. Please refer to the HP manual for specific regulations.

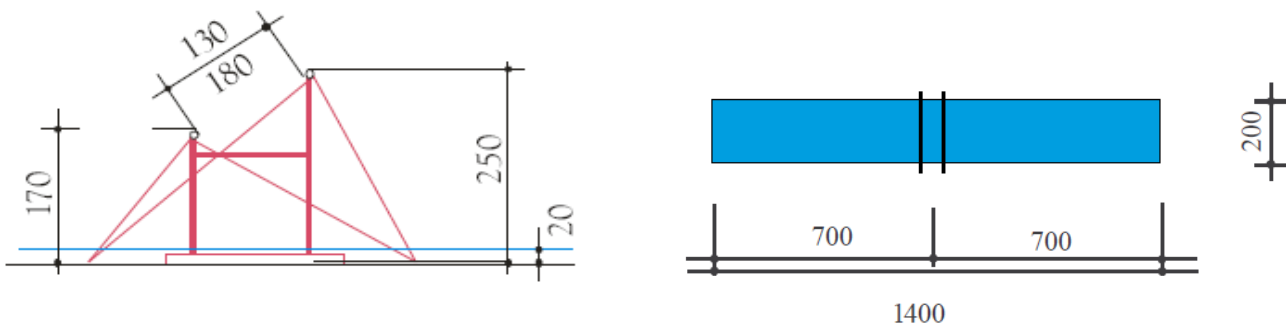

Measurement and set up Instructions:

The setting for the standard FIG diagonal distance should be marked on the adjuster. Reference marks to identify the chain links will be used once the UB are set at FIG. The reference marks may not be removed. If links must be added to raise the UB, coaches will be required to set the chains back to the original setting (links identified by the reference marks) once their gymnast has completed her warm up or competition.

Measure the diagonal: Measure the rails from the inside of both rails, in diagonal, from “wood to “wood”. For more accuracy, measurements should be taken where the wooden part of the rail inserts into the metal tube. This will ensure that the tape is straight and perpendicular to both rails

Height is measured from the upper edge of the rail while diagonal is at 180 cm. Measure the rails from “wood to floor” for height.

Raising the bars: Tall gymnasts who touch the mat with their feet are allowed to raise both rails by 10 cm.

Judges' Tables:

There must be a minimum distance of 3 meters between the edge of the judges' tables and the metal frame of the bars. Judges must be seated on both sides of the bars. The judges seated opposite to the D1 judge should be seated at separate desks or tables.

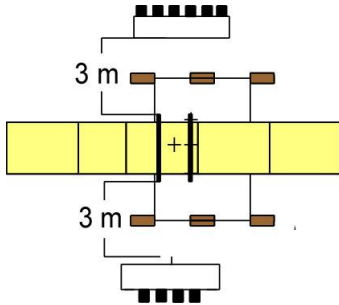

- 4 Judges chairs at table 1 and 2 judges chairs at table 2
- 2 set of flash cards for D and E scores placed in front of the D jury
- E score bonus cards in front of D 1
- 1 Chair for a runner/Scoring assistant for redundant scoring set up seated at table 1 next to the D1

Reference Camera:

The reference camera should be set up 2 m behind the position of the D panel. The camera must be on a fluid tripod that can pan left to right and set such that the entire landing surface (from closest edge of mat to opposite) is visible without obstruction and framed such that the camera does not need to be panned up or down (up to 2.5 m visible above high bar).

BALANCE BEAM

Height: 125 cm to the floor (± 1 cm)

Landing mats: 20 cm (± 1 cm)

Mount and dismount: 400 cm at one end of the beam (dismount end) – All gymnasts are expected to dismount on the end of the beam with the shortest mat.
 500 cm at the other end (mount run up area)
 An extension mat 200 cm x 100 cm x 20 cm may be placed on the side of the 500 cm mat. The extension mat may also be same width as the landing mat.

Supplementary mat: 400 cm x 200 cm x 10 cm (± 1 cm). Its use is mandatory. Supplementary mats are only available on one side of the beam only. Novice: A 20 cm safety mat is permitted for dismount.

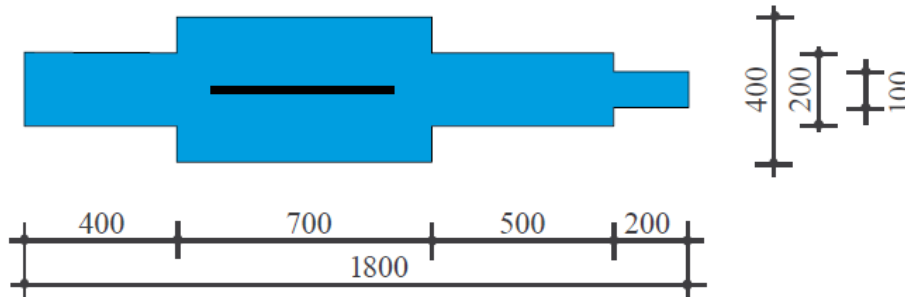

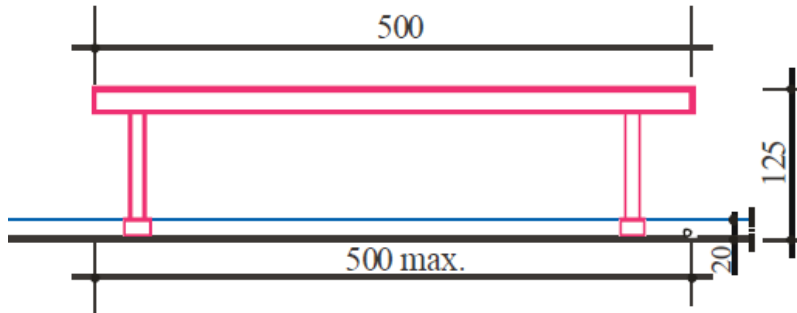

Board: A soft springboard must be available. (A small board may be available to place under the springboard)

Measurement and set up Instructions:

Measurement is taken from the top of the beam to the floor. For more accuracy, measure each side of the beam. If there is a need to measure the height of the beam to the top of the mats (125 cm – 20 cm = height of 105 cm to the mat), the weight of the person measuring will affect the height of the mats, thus the measurement for height of the beam may not be accurate.

Judges' Tables:

There must be a minimum distance of 2 meters between the edge of the judges' tables and the edge of the mat. Judges must be seated on both sides of the beam. The judges seated opposite to the D1 judge should be seated at separate desks or tables.

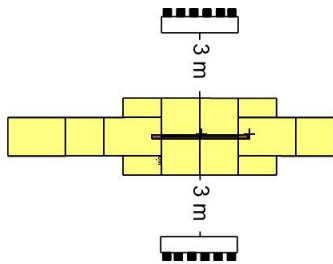

- 4 Judges chairs at table 1 and 2 judges chairs at table 2
- 2 set of flash cards for D and E scores placed in front of the D jury
- 1 Chair for a runner/Scoring assistant for redundant scoring set up seated at table 1 next to the D1

Reference Camera:

The reference camera should be set up 2 m behind the position of the D panel. The camera should be mounted on a fluid tripod that can pan side to side and up and down. The routine should be recorded with space visible below the level of the beam. The framing should ensure that the entire landing area is visible without obstruction when the camera is panned down on dismount.

FLOOR EXERCISE

Apparatus Per FIG 12m x 12m
 Supplementary Mat: Up to one (1) 5 cm or 10 cm mat is permitted

Measurement Instructions:

The White line is considered in bounds. Measurements should be taken along four points approximately 1.5 m from each corners on each side. Measurement will be taken from the outside of the white line to the outside of the opposing white line.

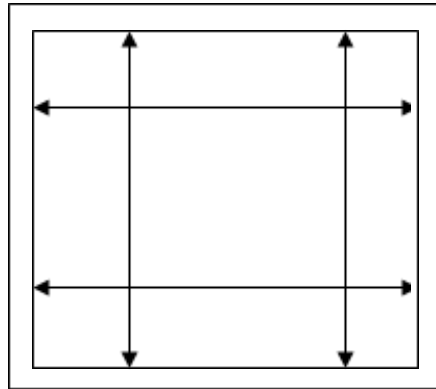

Judges' Table:

There must be a minimum distance of 2 meters between the edge of the judges' tables and the edge of the floor exercise mat. Judges must be seated at two tables along two perpendicular sides of the mat. The judges not seated with the D1 judge should be seated at separate desks or tables.

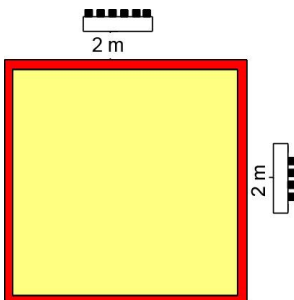

- 4 Judges chairs at table 1 and 2 judges chairs at table 2
- 2 set of flash cards for D and E scores placed in front of the D1
- 1 Chair for a runner/Scoring assistant for redundant scoring set up seated at the table 1 next to the D1
- 1 chair for timer

Line Judges:

Two line judges will be set at opposing sides of the floor with one at the corner to the right of the judging table and the second on the far side of the floor to the left of the judging table.

Reference Camera:

The reference camera should be set up 2 m behind the position of the D panel. The camera should be on a fluid tripod and set such that the corners of the floor are visible without obstruction.